

# SEACHROME

Seachrome Corporation  
 1906 East Dominguez Street  
 Long Beach, California 90810  
 Phone: (800) 955-2476  
 Fax: (800) 444-3380

Description:

## VERTICAL ANGLE BAR (Left Hand)

Seachrome Part #

GSVL-Series

Customer Part #

04-16-2018

### FLANGE STYLES

#### EXPOSED SCREW FLANGES

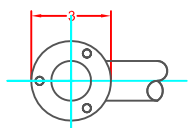
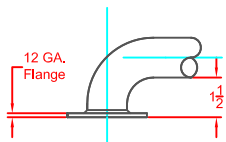

ER

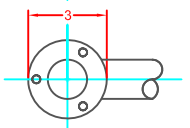
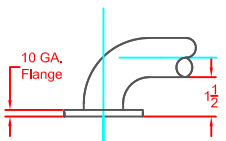

EW

#### CONCEALED SCREW FLANGES

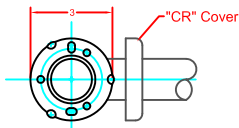
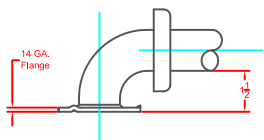

CR

#### CONCEALED BOLT-ON

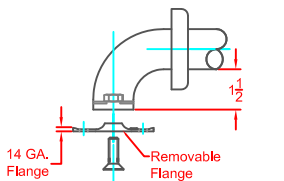

CB

### TUBING MATERIAL:

- "S" = Type 304 (18-8) Stainless Steel     "B" = 260 Alloy Solid Brass
- "D" = PVD finish over type 304 (18-8) Stainless Steel (Specify Color \_\_\_\_\_ )
- "P" = Powdercoated type 304 (18-8) Stainless Steel (Specify Color \_\_\_\_\_ )

### TUBING SIZE:

- "Q" = 1-1/4" (32mm) O.D. x .049" (18ga.) (1.2mm) Wall Thickness.
- "H" = 1-1/2" (38mm) O.D. x .049" (18ga.) (1.2mm) Wall Thickness

### FLANGE STYLE:

The following mounting flanges are constructed of Type 304 (18-8) Stainless Steel, Heliarc Welded to the bar to form an intergral structural unit.

- "ER" 12 ga. (2.8mm) x 3" (76mm) dia.
- "EW" 10 ga. (3.6mm) x 3" (76mm) dia.
- "CR" 14 ga. (2.0mm) x 3" (76mm) dia.
- "CB" 14 ga. (2.0mm) x 3" (76mm) dia.

The following flange is constructed of type 304 (18-8) Stainless Steel bolted to a threaded insert to form a structural unit.

### WALL CLEARANCE:

On straight bars, the standard wall clearance between the finished wall surface and the inner bar edge is 1-1/2" (38mm). Other Clearances upon request.

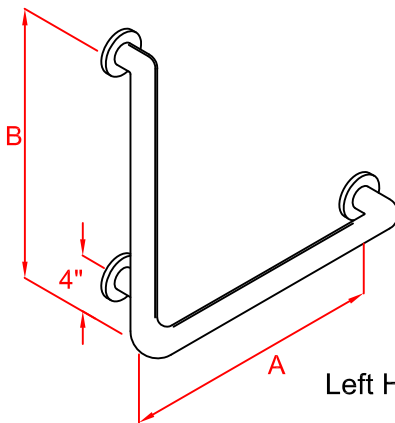

Left Hand Shown

### MADE IN THE USA

All bars meet Federal specifications WW-P 541/8b, Amendment 1, 16 April, 1990 ANSI 117.1 all FHA, VA & HUD specifications and

### COMPLIES WITH ALL ADA REQUIREMENTS



- S= Satin #304 Stainless Steel
- X= Polished #304 Stainless
- Y= Peened w/satin ends
- Z= Peened w/polished ends
- B= Polished #260 Brass
- P= Powder Coated #304 Stainless
- D= PVD

Dimension "A" + "B"    Tubing Size    Flange Style

Example: GSVL -- 240360 -- H -- CR

All grab bars must only be installed using sufficient in-wall backing material.