



Product data sheet

Shower grab rail with sideways adjustable vertical support bar and shower head holder 900.35.462XA

HEWI



Similar picture

Shower grab rail with sideways adjustable vertical support bar and shower head holder 900.35.462XA

- vertical and horizontally arranged rails connected at right angles with mounting roses and shower head holder
- with shower head rail that can be pushed to the side (for installation)
- vertical length 49 3/16 inch (1250 mm), horizontal length 36 inch (914 mm), 2 3/4 inch (70 mm) deep
- rail diameter 1 1/4 inch (32 mm), tube thickness 1/16 inch (2 mm), rose diameter 2 3/4 inch (70 mm)
- made of high-quality stainless steel, satin
- shower head holder made of high-quality matt polyamide in the HEWI colours 98 (signal white) and 92 (anthracite grey)
- suitable for shower heads of various manufacturers
- shower head holder can be tilted continuously and, after pressing a large pushbutton, its height can be adjusted
- conical adapter on shower head holder makes it easier to hook in the shower head
- including non-corrosive and tested HEWI fixing material for wall mounting and sealing tape for sealing the drilling points
- maximum loading capacity 330 lbs (150 kg)
- fulfils the requirements of the 2010 ADA Standards and ICC/ANSI A117.1-2017



ADA compliant

Dimensions in mm

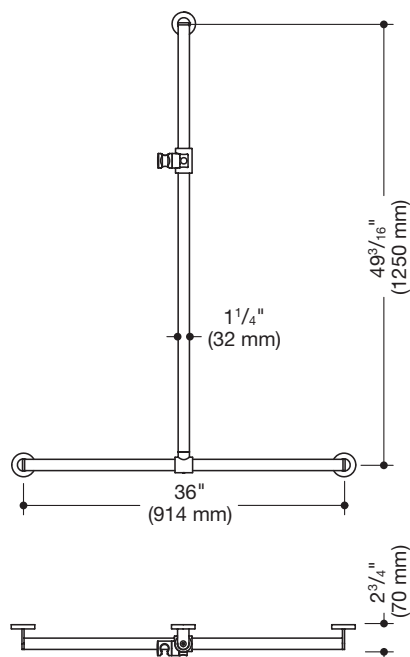

Surface/Colours



Alternative surfaces/colours



Powder coatings

The colour AX will be discontinued 31.03.2023

Technical information subject to alteration, 30th March 2022

HEWI Heinrich Wilke GmbH
Postfach 1260
D-34442 Bad Arolsen

Telefon: +49 5691 82-366
Telefax: +49 5691 82-99366
international@hewi.com
www.hewi.com

HEWI (UK) Limited
Holm Oak Barn, Beluncle Halt
Stoke Road
Hoo Kent ME3 9NT

Phone +44 1634 258 200
Fax +44 1634 250 099
info@hewi.co.uk
www.hewi.com