

Product data sheet
Fixing Type BA4.... BA4.60.70

HEWI

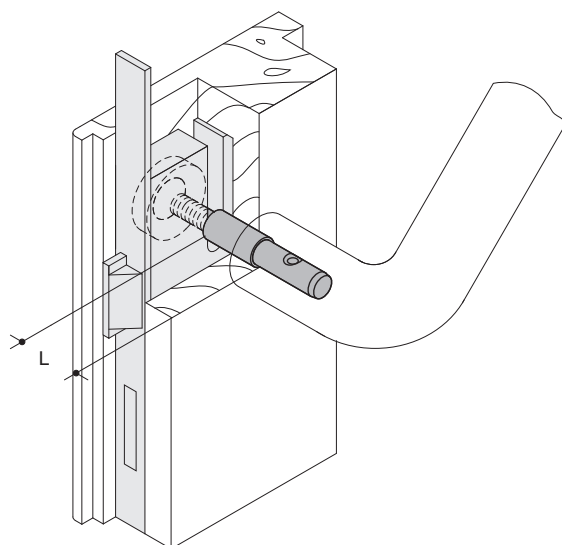

Fixing Type BA4.... BA4.60.70

for back-sided handle fixing with blank rose on solid wood, PVC and 2-3 chamber aluminium profiles.
Drillhole in the door 12 mm diameter, dimension L = insertion depth, Diameter of the cap 33 mm. Dimension L 6 mm, door thickness 60 - 70 mm.

Colours



Polyamide

Alternative colours



Polyamide, mat

Technical information subject to alteration, 17th August 2019

HEWI Heinrich Wilke GmbH
Postfach 1260
D-34442 Bad Arolsen

Telefon: +49 5691 82-366
Telefax: +49 5691 82-99366
international@hewi.com
www.hewi.com

HEWI (UK) Limited
Holm Oak Barn, Beluncle Halt
Stoke Road
Hoo Kent ME3 9NT

Phone +44 1634 258 200
Fax +44 1634 250 099
info@hewi.co.uk
www.hewi.com